

# THE BARD'S TALE III



*Clue Book*



### BARD'S TALE III: THIEF OF FATE

Arbo yawned, rolled over, and resumed watching the fight. His lord, Sir Rand of Nielan, still moved pretty fast for an old man. With agility that belied his bulk, the old man danced around four squat, hairy Hookfangs that were trying their best to surround him. Sir Rand was visibly enjoying this sport, taunting the foul creatures with jeers and laughter, which only added to their growing frustration. The Hookfang to Sir Rand's right grew impatient and charged with its spear. The old knight struck the monster's weapon to the ground, and with a graceful backhand severed the creature's neck with his broadsword.

Arbo gazed up into the leaves of the tree, absently watching the play of sunlight between the branches. He liked to sleep, and Sir Rand's relentless heroism interrupted his favorite activity. For his life, Arbo could not figure out how he'd been suckered into becoming Sir Rand's squire. It was scarcely more interesting than being a mill-horse. The pay was no better, the food equal if not worse (as squire he did the cooking), and as of late there had been no improvements on the scenery. And inevitably there would be weapons to clean with nasty bits of creatures clinging to the blades...

Another Hookfang raised a high-pitched battle-cry and charged. The old man stepped neatly to the side and ran the edge of his shield squarely into the Hookfang's face. With a squeal it dropped its spear and fell backward. The last Hookfang stood watching, hopelessly dumbfounded. Sir Rand walked briskly up to it and clubbed it over the head. It dropped like a rock.

"Here, Arbo," the warrior said, approaching his squire, "Clean these up." Sir Rand deposited his weapons in front of the boy. A rivulet of Hookfang blood landed on Arbo's arm.

"Oh...dis...YU-U-K!" he cried, wiping the mess furiously on the grass. "And don't forget," his lord continued, stretching himself over the cool carpet of grass below the oak, "Put a good coat of oil on those weapons, so they don't rust."

You never give me a chance to forget, muttered Arbo. Out loud he asked, "My lord, what are we doing out here?"

"Waiting for a wizard," answered Sir Rand.

Great Fenris' Furballs! exclaimed Arbo under his breath. Not another one of Old Rand's wizard-cronies! Next thing you know they'll be loaded and recalling the good ol' days when there was real evil to be fought...

Arbo half-heartedly set to cleaning but was soon gazing off toward the horizon, his mind settling into fantasies of perfumed pillows, exotic wines, and distant lands.

From under the oak Sir Rand caught the boy dreaming again and summoned Arbo back to the work at hand. "Arbo, you lazy cur," cried Sir Rand, "How many times do I have to tell you to concentrate on what you're doing!"

"What?" mumbled Arbo, blinking.

"I said," continued Sir Rand, irritated, "You are the laziest and most irresponsible squire I have ever had. I barely turn my back and you're daydreaming or asleep. It's about time you learned a little discipline. Do you know what I'm going to do with you?"

"Send me home?" asked Arbo, suddenly excited.

"Not at all," said Sir Rand, frowning, "Alfinius the Archmage needs you..."

Sir Rand was interrupted by a fireball flying slightly above the ground. It came zig-zagging across the field toward the oak under which Arbo and Sir Rand sat. Arbo wasn't particularly impressed. He knew that only a wizard would put on such a showy entrance. The fireball hovered before them for a moment, sputtering, and in a blink there stood a short pudgy codger with a beard that flailed out in all directions.

Alfinius and Sir Rand greeted each other warmly.

"Have I got some stories to tell you..." said Alfinius.

Arbo could not suppress a moan.

"Ah," said the wizard, "This must be your squire!"

"In a manner of speaking..." muttered Sir Rand.

"I suppose you already told him of the little favor he's going to perform for me?" asked Alfinius.

"I was just getting to that," said the knight.

"Look here, Arbo," said Alfinius, now addressing the squire, "The folks of Skara Brae — what's left of them — are in desperate need of stout warriors. A pupil of mine asked that I send him a fighter for the party they are forming. With Sir Rand's permission I would like to send you."

"Uh...me?" asked Arbo in total disbelief. "A warrior?"

"Of course, there will be some danger as well, but I'm sure you thrive on that," continued Alfinius.

"DANGER!" exclaimed Arbo. He looked to Sir Rand imploringly. "Can I say 'no'?" he asked.

"No you may not, Arbo," said Sir Rand, "Now go pack your things."

Arbo unhappily started collecting his possessions.

"Do you think he'll learn any responsibility from this?" Sir Rand asked the wizard.

"Perhaps more than you think," said Alfinius.

Arbo stood ready. Sir Rand outfitted him with some scrappy armor and a sword. Alfinius told him who he should seek out once he arrived and teleported the boy to Skara Brae..

## SKARA BRAE, THE RUINS

Arbo arrived in the Refugee Camp and for the first time in his life he had to take a little initiative. He found Alfinius' pupil, Morolinith, who introduced him to the rest of the party. Their leader was an elegant half-elven swordsman named Origen. Origen had a brother named Adelard who was an accomplished bard. Though they resembled each other, the brothers were quite opposite in nature: Origen was older and very serious, while Adelard was lazy, almost frivolous. Nadya was the party's thief, a tough, street-wise girl who readily spoke her mind. Arbo soon grew fond of her, even if the others did find her a little too blunt. The party also had another spellcaster named Thalia who, like Morolinith, was well-learned in more than one realm of magic.

Since Skara Brae was now nothing more than gutted buildings and a camp full of ragged survivors, Arbo hoped he wouldn't have to stay long in such a place lacking in comforts. He didn't really know what they were supposed to do there. From speaking with the Old Man at the Review Board, he soon learned that Tarjan, the Mad God, was responsible for the destruction of the city. Brilhasti Ap Tarj was one of Tarjan's lieutenants, and somebody had to kill him. Arbo inferred that they were the fools who were going to try it. Arbo suggested they wait for Brilhasti to come to them — perhaps in the Scrapwood Tavern. The idea didn't go over too well with the others.

The following morning they were on their way to the Temple of the Mad God, home to Brilhasti. The party entered the ruined city from the west and walked east toward what once was the Gran Plaz. Once bustling with activity, the Gran Plaz was now deserted except for a colossal statue of Tarjan standing triumphant in the center of the square. As they walked past the statue, Nadya went out of her way to spit on it.

"Careful," said Origen sternly, "We don't need Tarjan's special attention."

"Bring him on!" said Nadya through clenched teeth. "I'll kill that coward yet!" Her resolution was such that no one argued with her, but Origen was clearly unhappy with her brash actions.

In the temple, a cowed figure silently emerged from the shadows and stated that only those who knew the true name of the Mad God would be welcome. Nadya stepped forward to tell the priest what she thought it was, but Origen glared hard at her.

"Tarjan," he said firmly.

A wry smile spread across the priest's face, and with a sweeping gesture he led the party to the stairwell.

### LEGEND FOR MAPS

- A Stairs or portal down
- B Stairs or portal up
- C Teleport to new location  
(may require special word)
- D Passageway to new  
location (may require  
special word or object)
- G Statue of a god

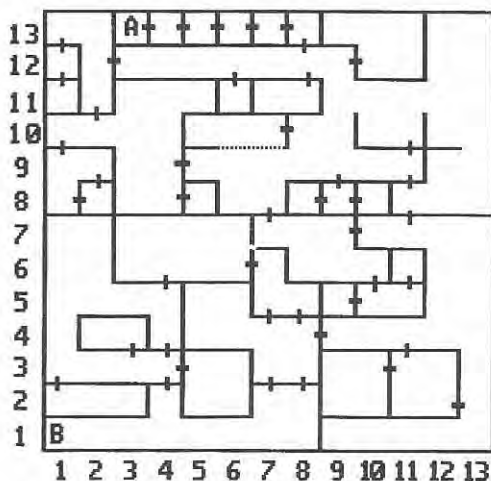

CATACOMBS 1

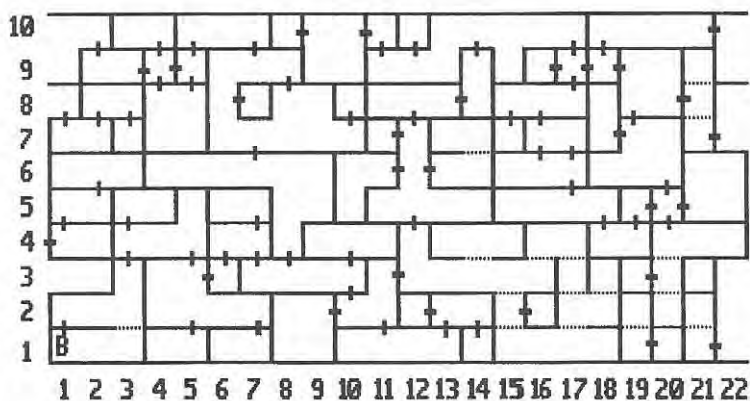

CATACOMBS 2

## SKARA BRAE, CATACOMBS, LEVEL 1

At the bottom of the stairs, the party lit a torch. They walked to the end of the corridor, then turned left, passing through a door. Arbo tripped and fell to the floor just as some spikes flew inches from his face. Arbo took one look at the wicked, barbed device glistening with poison, and promptly fainted.

Origen looked to Morolinith. "Are you sure you made clear it was a warrior we needed?" he asked.

Morolinith shrugged. They revived Arbo and placed his sword and shield back in his hands. The party turned right, then left into a large corridor and headed north. At one point Nadya told them all to stop.

"Listen," she ordered. What first sounded like a draft blowing through the deserted halls turned out to be some kind of ethereal voice. "The priests seek another word..." it seemed to be saying.

"Sounds to me like they'd like to talk to us again!" said Arbo turning to go. Origen grabbed him by the collar before he'd taken two steps.

"You're not a coward, are you, Arbo?" he asked.

"Uh...no," said Arbo, startled.

"Good," said Origen. The rest filed past Arbo through the door.

"I just have cowardly feet," mumbled Arbo to himself.

Along the northern border of the catacombs they discovered a series of small rooms, one after another. Arbo gulped as they came face to face with a large group of vile monsters. Arbo swung wildly and didn't hit a thing. Fortunately, what the spellcasters didn't burn to a crisp, Origen, Adelard and Nadya mopped up. Out of kindness, or embarrassment, no one said anything about Arbo's fighting prowess.

Thalia sensed a trap in the next room and disarmed it. "Traps, beasts..." mused Morolinith, "They must be guarding more than these chests." In the last room they discovered stairs descending into the darkness.

## SKARA BRAE, CATACOMBS, LEVEL 2

From the base of the stairs the party took the only door leading north. They walked straight ahead and found that a wall had appeared behind them! Since there seemed no going back they moved west. Soon it was apparent that they were somehow now at the other end of the dungeon. They were also in darkness as their torch was magically snuffed out.

"This is a great start," sighed Adelard, who thought that a good enough reason to swill a little wine. They moved on and Adelard played a tune, his notes lighting the way.

"A fanatic was here," said Nadya, pointing to a wall. In blood, painted in large letters, was the word CHAOS.

"If the priests are seeking another word, there's one down here in their dungeon," said Adelard. "What do they want it for, though?"

With no obvious answer, the party moved westward through narrow chambers, trying to avoid monsters and traps. At every turn they half expected to meet Brillhasti. After a while it became apparent that Brillhasti didn't lodge on this level. The party then looked for more stairs down, but didn't find those, either.

After hours of searching, Arbo spoke up. "We need sleep," he said wearily. The others could only agree and decided unanimously to head out and try again the next day. On the way out Arbo noticed a message scrawled on the wall: "This word will allow access to the unholy domain of Brillhasti Ap Tarj." Arbo was about to point out his discovery, but remained silent at the last moment. They left the catacombs and returned to camp.

## SKARA BRAE, UNTERBRAE, LEVEL 1

The priest once again challenged them to give the correct name of the Mad God.

"CHAOS!" blurted Arbo, much to everyone's surprise.

The priest bade them to enter the realm of Brillhasti Ap Tarj, leading them to a different set of stairs. The others nodded to Arbo, acknowledging his cleverness. Arbo suddenly felt a little useful.

The party walked down, and Thalia cast a spell for light. Almost immediately they heard low moans approaching. They hid in an alcove, only to watch the stiff, mindless forms of the undead lurch past. The party walked to the west, investigating every alcove. In one was written, "The shade of the wind's home will set you free."

From here the party moved north. They found another message on the wall: "A splash of noble's blood colors the exit." This was just as ambiguous as the previous message. The party turned east and discovered another series of connecting rooms. The spellcasters noticed right away that their power was being drained by some negative force.

"Before we run the gauntlet of those corridors, we'd better figure out the answer to the next riddle," said Morolinith. The party explored some more. In the northeastern corner of the level they found another clue: "A tint of melancholy paves the way." The group was silent for a moment.

"Blue?" asked Arbo.

They looked at each other. The word seemed to satisfy all the riddles. At the end of the winding corridors a magic-mouth appeared. "Speak the rhyming word to pass through," it said.

"You may have the honors," said Origen.

Arbo spoke and the party entered the next level.



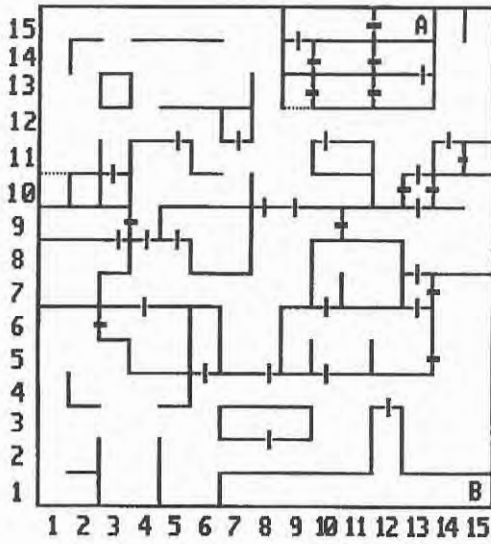

UNTERBRAE 1

UNTERBRAE 2

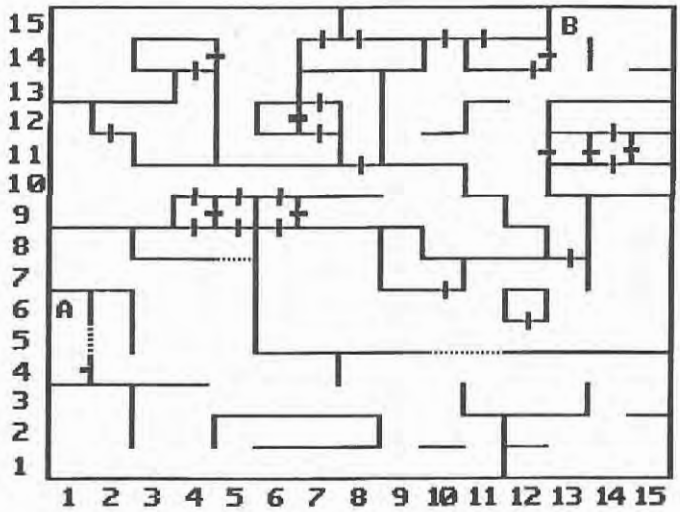

## SKARA BRAE, UNTERBRAE, LEVEL 2

Putrid smells greeted the party at the bottom. They hurried to the south. In one complex of rooms they found a message scratched in the wall: "Light hurts me and bleeds me, but leaves me behind it always."

Arbo had an idea what the answer was. He was feeling very clever now, and his enthusiasm had grown so much he was walking five feet in front of the others as they continued south.

"Yow!" yelled Arbo, falling down. He was holding his nose. Origen stretched out his hand into the air.

"Looks like Arbo discovered an invisible wall!" said Origen. The others laughed. "You're lucky it's only your nose that's bloody," said Origen as he helped Arbo to his feet.

They walked along the wall, feeling for an opening. About twenty feet away their hands slipped through. The group walked through and a visible wall formed behind them. Arbo feared that they were sealed in for good until they came across another message which read: "Down below, eschew the first right thing to do." There must be stairs going down somewhere, reasoned Arbo; of course, whether or not that was the best direction to go was another question.

Near the southwest corner the party discovered another invisible wall. Through it they could see a door leading into a chamber with stairs leading down. They walked around to where the door logically would have been but found only wall. A faded figure appeared asking "I am nothing but my opposite creates me even as it destroys me." From the flickering light behind him Arbo saw the answer before his eyes. He told the ghost SHADOW and the door appeared. They walked through. Inscribed over the door was a cheery message: "Return from beyond this place is not possible by this means." Arbo managed to find some courage and forced himself to follow the others.

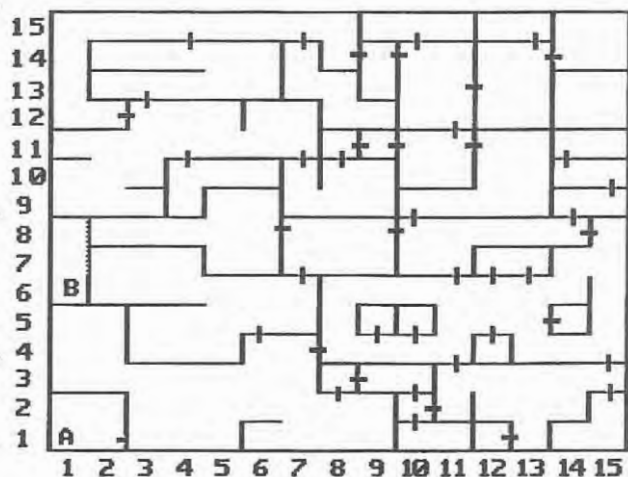

UNTERBRAE 4

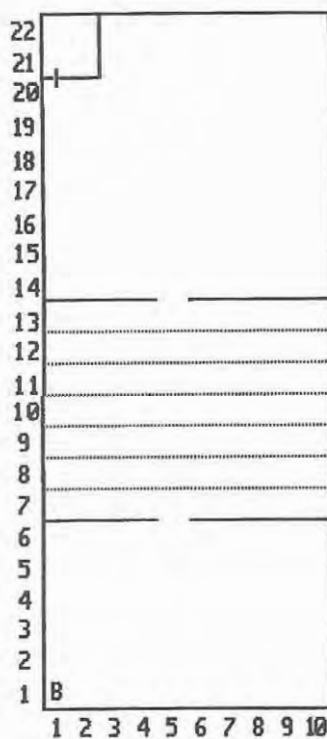

### SKARA BRAE, UNTERBRAE, LEVEL 3

All the way down the stairs, Arbo tried to puzzle out the only clue for this level.

"If we eschew the first right thing to do," he rambled out loud, "Then that is supposed to be better for us. Hence, it'd be the right thing. But! That's precisely what we're supposed to avoid. So we have to purposely do something wrong..."

Nadya slapped Arbo on the head and pointed. From the bottom of the stairs the corridor ran about thirty feet and turned to the right.

"That's the 'right' thing we have to 'eschew', you lunkhead!" said the thief, referring to the adjoining corridor. "No more puzzles for you."

"But how will we get out of here, then?" asked Arbo a bit nervously.

Thalia stepped forward. Everyone moved back as she cast a spell that instantly vaporized the wall to the north.

"North, I guess," said Arbo, very much impressed.

While the party explored the level they found more warnings inscribed on the walls. The warnings mentioned three "wards" on the next level. Just what was meant by "wards" was uncertain. Were the wards actual beings or only some means of defense? Morolinith wrote the warnings down exactly as he saw them on the walls so that they could refer to them...if there was time.

In the southwest corner of the dungeon another figure appeared and spoke a riddle: "I have no lips yet my kiss is deadly. I am not a razor, but those I caress need never shave again. Your best friend, I will kill you. Speak my name, then ready me."

"Sword," answered Origen, and there was suddenly a door before them.

"How did you know?" asked Arbo, as they filed through the doorway.

"When it said, 'Your best friend, I will kill you,' I thought of the old adage: 'He who lives by the sword, dies by the sword,'" said Origen.

"I won't," said Arbo.

"Your courage is admirable," said Origen.

Arbo didn't mention that what he'd really been thinking was that he didn't plan on making his living by the sword.

The access to the next level was a hole in the floor. Thalia cast a levitation spell and soon the party was floating down to the floor below.

## SKARA BRAE, UNTERBRAE, LEVEL 4

They landed in a truly immense cavern.

"Read us the warning concerning the first ward," said Origen calmly. Morolinith held the parchment under the light and read.

"Doesn't make sense," said Nadya.

"But look at the odd spelling," said Thalia, "The capitals are points on the compass!"

"Yes!" said Origen, "That's how we're to proceed! Follow me!"

Origen measured his steps carefully. The others followed as Morolinith read off the directions: "North...East...North..." Their circuitous path paid off, for they soon arrived unscathed at the portal joining the first massive hall with the second.

Morolinith read the second warning and they heeded it by continuing along the perimeter. Adelard felt a little nervous about the place so he pulled out his mandolin and strummed the Safety Song. The party soon reached the second doorway.

Nadya spoke up. "Did you notice how incredibly foul the air is here?"

"Did you also notice," said Morolinith, who was bringing up the rear, "That the south wall seems to have followed us here?"

The others gasped, realizing they were locked in.

"Brilhasti really wants to meet us, I guess," said Arbo, whose poor attempt at humor didn't cover his quickly draining confidence.

The party walked the perimeter of the last ward, disarming traps and getting lost in darkness so deep that no light could penetrate it. They arrived at a door and burst through. The room appeared empty but a deep, heavy breathing reverberated through the chamber. Suddenly Brilhasti in all his hideousness appeared along with four of his dark minions. The mages blasted the guards with fire spells. They turned on Brilhasti but he had summoned Greater Demons to help him. Thalia cast a spell to close the enemy's summoning gates. They slew the demons and advanced toward Brilhasti. Brilhasti's spells brought shards of ice on the heroes. Eventually the fighters closed in on Brilhasti and Nadya attacked from behind. His loathsome screams brought no pity, only renewed assault. As they stood around their slain foe, they felt a force surrounding them, and soon they were standing before the Old Man at the Review Board.

At this point, Morolinith had to graduate from Archmage to Chronomancer or else they'd never leave Skara Brae. When the Old Man finally got done teaching Morolinith the spells of time-travel, they were ready to move on. As the party took their leave, the Old Man's last bit of advice was to be on the lookout for an ally.

## ARBORIA, CIERA BRANNIA

Alfinius came to meet Arbo in the Refugee Camp.

"Well," said Alfinius, "Sir Rand will be glad to see that his squire is still kicking. You even look a little healthier for it, perhaps. So, are you ready to go?"

"Um...I'm not going," said Arbo, "Not yet."

Alfinius looked surprised, but not angry. Then again, maybe not even all that surprised, either.

"Well, er...what do you mean?" asked Alfinius, "Sir Rand is expecting you."

"My friends will be continuing their quest. I can't let them down when they need me," said Arbo.

Need! thought the wizard, That's a good sign. "You do what you think is right, boy," said Alfinius, a shrewd smile on his face. "I'll explain your decision to Sir Rand."

"Ha! Old Rand got more than he bargained for! Serves him right!" said Alfinius to himself. He chuckled and was gone.

It was some time before the group was ready to undertake the Old Man's next task: retrieving Valarian's Bow and the Arrows of Life. The party met in a peaceful grove just southwest of camp. Morolinith was making a few last-minute calculations. They stood in a ring and joined hands, while Morolinith intoned the names of various powers. Everything was a blur for a moment, and then they were standing in a lush, wooded landscape.

An aging fighter greeted them warmly as old comrades and asked to join them. Nobody knew him or what he was talking about. Origen called a conference.

"He seems full of good will," said Adelard.

"A little weird," added Nadya, "But we certainly could use a burly fighter like him — no offense, Arbo. Besides, the Old Man told us to be on the lookout for an ally."

They agreed to let the fighter join their party, and soon found out he was the legendary Hawkslayer. They were glad to have him along, even if he did keep quiet for the most part.

Origen thought it a good idea to talk to the King before they walked off with Valarian's Bow. The King didn't seem too happy to see anyone. He knew why the party had come, he told them. Furthermore, he said they would have to kill the accursed Tslatha Garnath if they wanted the bow. To slay him they would need the Nightspear in Valarian's Tower. What would they need to get into the Tower? Arbo wanted to know. The King thought the question a little impertinent, and amidst regal screams Origen suggested they get out before they ended up in manacles somewhere. The party spent the night in the Wizard's Guild.

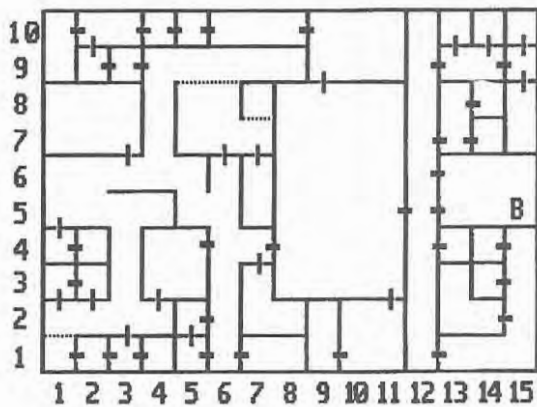

THE PALACE

## ARBORIA, CRYSTAL PALACE

Arbo stopped under an oak tree. He was enamored by its singular beauty.

"C'mon, Arbo," said Origen, "We don't have time for communing with nature."

Arbo quickly picked up a few acorns and put the souvenirs in his pocket. A little farther on the party came upon a small fishing hut by a lake. Inside they met an old fisherman. Origen didn't want to waste time exchanging fish-stories, but Adelard convinced him that the old fisherman might know something of use. With a little incentive (of a golden hue), the fisherman was soon telling them about the wonderful powers of the Water of Life which could be found in a submerged palace in the lake outside his back door. He would even teach them the spell Gill, which they could use to breathe underwater. (Morolinith, a bit of a green thumb, mentioned that Arefolia leaves, which could be found under a nearby tree, would also let them breathe underwater.) The party decided that if the water really had the power of regeneration, it would be worth the risk. There did seem to be a lot of Garnath's creatures lurking about, so they were sure to be in need of some healing-water.

The party climbed in and sank easily due to the weight of their possessions. They held their breath until they hit bottom, when Thalia cast the spell — and they could breath underwater. With another spell there was light by which they could see the splendor of this ancient palace. Moving west, the party entered a huge chamber — now a huge aquarium — filled with all kinds of sea-life. They managed to keep out of the way of the hungrier-looking varieties.

Still farther west they discovered the spring itself. They felt better just in its presence. Adelard filled an empty wineskin he'd been carrying and the party returned to the surface, quite refreshed. It was late, and since the old man didn't seem to object, they spent the night in his hut. After the most restful sleep of their lives, they were ready to find the Nightspear.



## VALARIAN'S TOWER

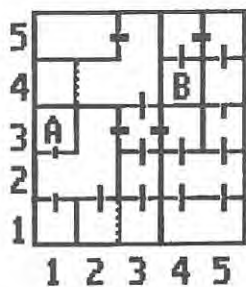

LEVEL 1

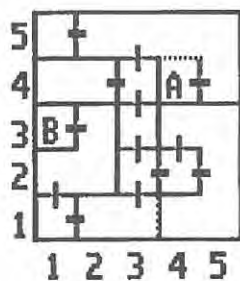

LEVEL 2

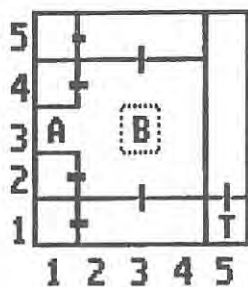

LEVEL 3

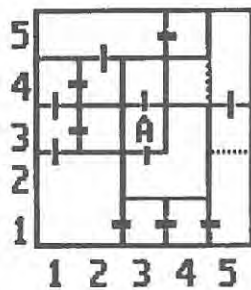

LEVEL 4

## ARBORIA, VALARIAN'S TOWER

With the sharpness of an elven eye, Morolinith spied the battered tower in the distance. As the party drew nearer it became obvious from the near-fallen state of the tower that evil had done its work here. The party entered and found stairs up. They clambered through each level looking only for the Nightspear. In the third level they quickly found the stairs leading to the last level, but the entrance was blocked by a huge stone disc. Carved into the stone was the picture of a sturdy oak supporting a disc in its branches. A small, conspicuous hole had been bored in the floor before the disc.

"All of us together couldn't move that," said Nadya.

Slowly, everyone turned to Arbo, expecting him to solve this riddle, too.

"What? Am I supposed to have the answer?" asked Arbo. He crammed his hands in his pocket and turned with a huff. Then he felt a small object in his pocket. He pulled out an acorn.

"Of course, it just so happens I do have the answer," said Arbo, not missing a beat. He placed the acorn in the hole, then stepped back, expecting a miracle. Nothing happened.

Adelard laughed. "Try half the answer," he said. "Do you expect anything to grow without water?" Adelard poured a little Water of Life on the nut and the tree grew rapidly, raising the disc high into the air. The party filed through the doorway.

In a small closet on the fourth level, the group found the Nightspear. After a little discussion, the party decided it would enter the Festering Pit that day and try to wrest Garnath's head from his shoulders.

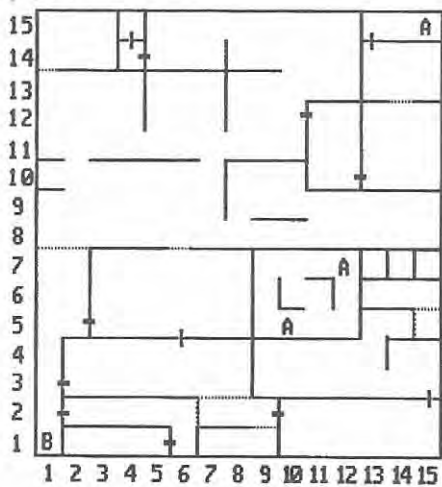

FESTERING PIT 1

FESTERING PIT 2

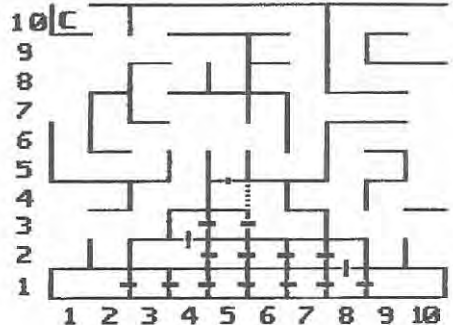
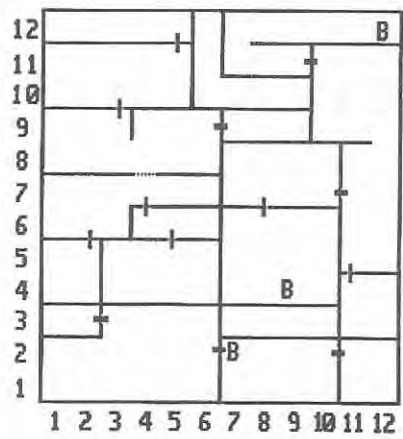

SACRED GROVE

## ARBORIA, FESTERING PIT

Outside of Ciera Brannia, the party found the entrance to the Festering Pit. They entered and were startled by a magic mouth that tried to intimidate them with threats, but they knew they had the Nightspear, the only weapon that could trap Tslotha Garnath's soul. The mouth blathered on but the party ignored it, continuing northeast, where they found stairs.

In the second level, the party searched in vain for Garnath. Thalia examined the map she was drawing and determined that a large portion of the dungeon to the west simply had no doors leading to it. The party wandered about searching for secret doors, but to no avail. Finally, in one large room, Origen noticed a portal in the ceiling. Thalia levitated the party through the hole. The room they stood in had no doors but across from them was another portal in the floor. Avoiding some invisible barriers, the party reached the portal and levitated back down.

"We outsmarted Garnath this time!" thought Arbo, but his optimism was crushed when they discovered they still couldn't gain access to a large part of the dungeon. After levitating up, and then back down in the first portal, they headed north. Thalia finally found a wall susceptible to her Phase Door spell. In a narrow chamber that ran along the northern wall the party encountered Tslotha Garnath. He laughed until Origen flashed the Nightspear and sank its ebony blade into Garnath's chest.

Origen turned to Arbo. "Arbo, could you get Garnath's head and heart? We need proof for the King, you know."

"I need a squire," mumbled Arbo.

## ARBORIA, SACRED GROVE

The King's mood changed when Arbo set Tslatha Garnath's bloody head before his feet. He was so elated he extended the fullest hospitality. After a night of celebration, the party visited the Sacred Grove in the center of the city to collect their prize — Valarian's Bow and the Arrows of Life.

Arbo was uncomfortable in the garden. The splendid autumnal colors were appealing to the eye, yet the grove's twisted paths and deceptive ways made him fear ambush at every turn. Arbo's fears were justified — more than once the party was set upon by wizards and their undead servants. The party found the entrance to Valarian's Tomb. The door was carved in the figure of Valarian himself. In place of his heart was a bowl with tubes running from it. A small plaque by the door stated that Valarian wished his heart to be healed of its ache.

Arbo had wondered why he was carrying around this heart. He pulled the bloody organ from his pack and set it in the bowl.

"This will pump the healing water," said Arbo.

Adelard added some water and the heart started beating. A door to the east appeared, which the party took to mean that Valarian was now at rest. They made their way to the burial chamber and collected the magic weapons. Hawkslayer decided he had more business on this world and chose to remain behind. The party departed to hand over the Bow and Arrows to the Old Man in Skara Brae.

## GELIDIA, ICE KEEP

Arbo had seen the deadly power of magic in the hands of Morolinith and Thalia, so it was with a little dread that he decided to help retrieve the Wand of Power and Sphere of Lanatir from the hands of evil mages who were guarding them. Furthermore, the party would have to travel to the dimension of Gelidia, a land of eternal winter as cold as magic itself, and Arbo really didn't like the cold at all...

"This isn't so b-bad," said Arbo through chattering teeth as they stood atop Cold Peak. Morolinith then cast his spell and the party stood on the frozen plane of Gelidia.

"But this is!" cried Arbo, jumping up and down, trying to keep warm.

It was beginning to snow. Fortunately, the Ice Keep wasn't too far to the north. They were running towards the towering fortification when they came across a hut. Inside wasn't much warmer than outside, but at least they had temporarily escaped the bitter wind. A frozen mummy was the only occupant there to greet them, and did a poor job at that. The mummy had few belongings of interest; Arbo only found a lengthy diary about a hero named Alendar worth reading.

They left the hut and made a fast, blood-circulating run for Ice Keep. From the outside, they knew there were two levels to the keep. Three separate towers — one grey, one white, one black — graced the top of the structure.

"Let's avoid the towers for now," said Morolinith, gravely.

"Why?" asked Arbo.

"Wizards have a great proclivity for towers," said Morolinith. "I'll bet five gold pieces that's where we'll find them."

The party searched the level, engaging in combat with the wandering hordes just to let the fire spells warm their hands. In the corners — just where they expected the towers to be — the party found strange inscriptions on the walls. Certainly these were more riddles, they figured, but the solutions that would gain them entrance were much less apparent.

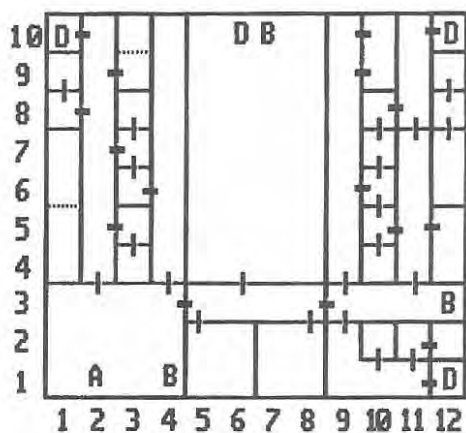

ICE KEEP 1

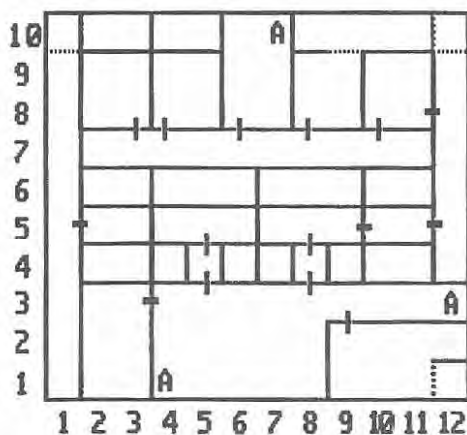

ICE KEEP 2

In a large hall, along the northern wall, the party found a curious circle of white marble set into the floor. Carved into the marble were three overlapping circles. A gold plug embellished the design. It was certainly magical, but no one could guess what its function was.

Not far from the magic white marble a stone guardian spoke:

“Speak your name, defender, and pass a friend.” Each tried their name but the guardian remained unmoved.

“I wonder if Hawkslayer would know whose name we should speak...” said Arbo.

Midway through Arbo’s sentence, stairs appeared before them. The others could only shake their heads at the weird luck Arbo sometimes seemed to have.

In the second level, the party wandered for a while but found no clues as to where the artifacts were hidden. The wizards themselves must be guarding them, they reasoned. With this unhappy thought, the party descended the stairs and made their way to the black tower.



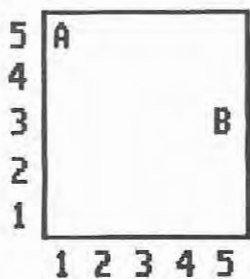

BLACK TOWER 1

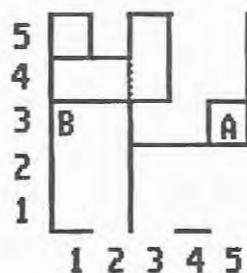

BLACK TOWER 2

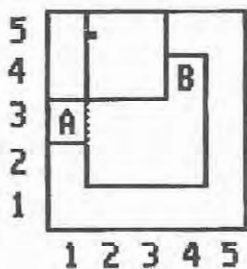

BLACK TOWER 3

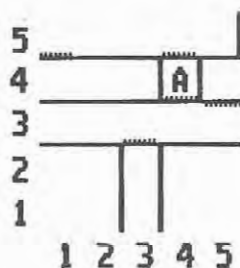

BLACK TOWER 4

fire  
shsp  
four  
sweat  
3001

## GELIDIA, BLACK TOWER

In the southeastern corner, the party found a glistening, black wall barring their way into the Black Tower. A curious riddle was written below it.

"Bright light, loud thunder...terror term....," read Arbo, "What could be all those things at once?"

The party stood for some time, pondering. The lantern faded as they pondered some more. The lantern went out. Thalia cast a Mage Flame, and the wall seemed to absorb the fire! Once more they stood in darkness. Thalia tried the spell again, and this time it stayed lit. She stood perplexed for a while, then laughed.

"Of course!" she cried, "That was a bright light! Now it seems so obvious: wizards would have *spells* as passwords to their domains!"

Obvious to a wizard, thought Arbo.

"Now let's see," continued Thalia, "We need loud thunder..." The wall sucked in her Shock Sphere spell as well. A few spells later the passage was before them and, unhindered, the party entered the Black Tower.

The tower seemed a product of chaos itself. The party could not explain how, but they ran into no walls, no matter how far they walked. After a few miles of random movement, the party came across a set of stairs.

They eagerly ascended to the next level. Here the party encountered some invisible walls. The entire level was baffling — though they walked one direction, they always returned to the same place. Eventually they found more stairs. Passing as quickly as possible, the party proceeded directly to the last level. In the darkest part of the tower, the party met the Keepers of the Black Tower: five black wizards. Thalia brought the foes closer and the party hit the wizards with everything they had. After an impressive exchange of fire, the five wizards lay smoldering on the floor.

The party was disappointed to find only an unimpressive black lens instead of the Wand and Sphere. Though they couldn't figure out what the object was for, they packed it away.

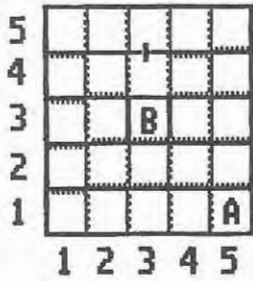

GREY TOWER 1



GREY TOWER 2

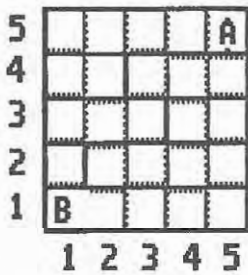

GREY TOWER 3

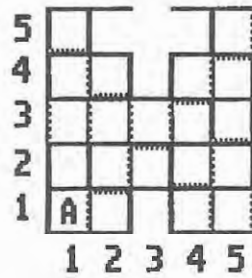

GREY TOWER 4

Inwo  
w i h e  
F U F U  
T A V I

## GELIDIA, GREY TOWER

The entrance to the Grey Tower was guarded by an obscene creature with four arms and three eyes. It, too, demanded a sacrifice of spells. Thalia gave it the ones implied by the inscription, and soon the party was exploring the tower.

The Grey Tower was not as amorphous as the Black, but equally sinister — walls appeared, then vanished, and traps abounded. In the highest level, the party found a clue on the wall: "Broken cross is the goal, yet hidden it doth be. Through the flaw egress is won..." The meaning of the riddle was not clear until Morolinith mapped the entire level. Then it became obvious that there were two sections they couldn't gain access to. The grey wizards were hiding in one of them.

Arbo read the riddle and compared it to the map. "Through the flaw....," he repeated. "If we can get into the 'broken' part, this room to the south, we should find who we're looking for."

Thalia attempted to vaporize the wall, but the spell failed. She had another idea. Everyone held hands and with Apport Arcane, she teleported the party into the room. They found they could walk south, and by the magic of the tower would appear at the north. Here, in the 'broken cross', the party fought seven grey wizards. The air crackled with spells, but steel won the day. Picking up another lens — this one smokey — the party discovered an exit to the east.

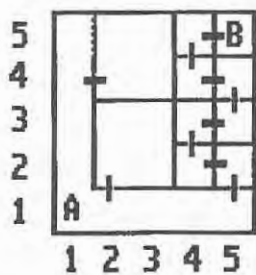

WHITE TOWER 1

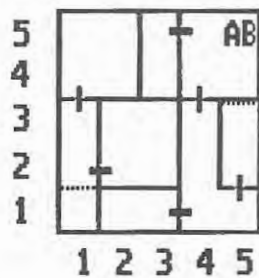

WHITE TOWER 2

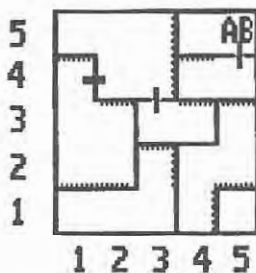

WHITE TOWER 3

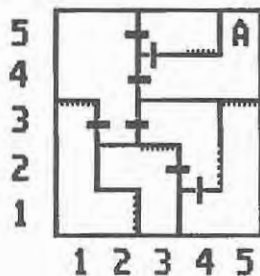

WHITE TOWER 4

Levi  
7/11/94  
phdo

## GELIDIA, WHITE TOWER

After casting the necessary spells, the party entered the White Tower. They quickly discovered that this corner of the Keep was colder than the rest: thick ice coated the walls, hiding much of the architectural beauty. Nonetheless, Adelard was so delighted with what he saw, he was disappointed when they discovered a single stairwell leading from the second to the fourth level.

"We must inspect the other two," he insisted.

Origen agreed at once they had dispatched the white wizards. In the fourth level they surprised six wizards with an onslaught of fire and sword. When the smoke cleared and the evil guardians were dead, the party found another lens.

"I can't believe they're only protecting these oversized chunks of glass!" exclaimed a frustrated Arbo.

"They must be protecting them for some special reason, though," said Nadya. "There not worth much, otherwise."

"Well, these rocks aren't the only mystery in this place," said Origen. "How about that white marble circle?"

"Indeed!" said Morolinith, "There could very well be a connection between that spot and these lenses."

On the way down, the party explored levels two and three. Adelard was in aesthetic bliss. Everyone was a little surprised to find nicely preserved murals depicting a young Hawkslayer and his love, Cala. They even found a small crib. Arbo was moved to tears as he realized what Hawkslayer had lost — and was avenging.

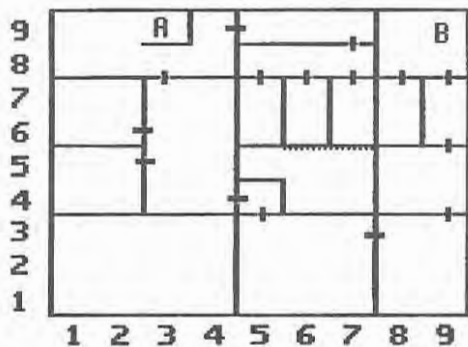

ICE DUNGEON 1

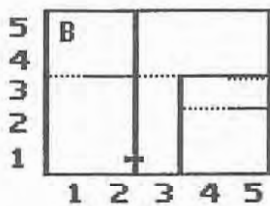

ICE DUNGEON 2

## GELIDIA, ICE DUNGEON

“The artifact must lie beneath this stone,” said Origen.

Since each of the overlapping circles had arrows pointing to its respective tower, the directions seemed fairly explicit. They placed the lenses in the circles, and were suddenly faced with stairs going down.

In the Ice Dungeon, they discovered evidence of a terrific battle. The cold kept many of the corpses well-preserved. It seemed apparent that Lanatir had taken his last stand against Tarjan’s forces here in this dungeon. The party picked their way through the carnage until they came to a stairwell in the northeastern corner.

They entered the second level and advanced south, then east, and then north. They passed through a troublesome hallway that absorbed their light, silenced their spells, and ate at their health. After they finally passed through, they found an inscription on the wall said that “only the name of his blood may enter.” Adelard, who’d paid close attention to the things he observed in the White Tower, understood the riddle. Cala was Lanatir’s daughter. The crib had the name of Utor painted on it. Utor was certainly the son of Cala and Hawkslayer.

“Cala,” tried Adelard, and a door appeared south. In a chamber to the south, the party discovered the Sphere of Lanatir and the Wand of Power. The items were warm to the touch. Arbo, who had been suffering throughout this entire trip, immediately offered to carry one — or both.

The party ventured back out into the wilderness of Gelidia and followed their footsteps to the teleport site, from which they returned to Skara Brae.

## LUCENCIA, CELARIA BREE

The Old Man told the party that next they would seek the Crown of Truth and Belt of Alliria in the dimension of Lucencia.

He didn’t mention that it was a truly bizarre place.

The dimension of Lucencia was surreal in comparison to Arboria and Gelidia. Its denizens were as colorful as the play of light on a diamond, though much more dangerous. The party continually found itself up against motley gangs of Crazy Eddies, Herbs, skeptics, and other creatures destined for the Loony Tunes Hall of Fame.

In the middle of this absurd place the party found a small city. They sought out the local tavern to hear the latest in Lucencia. The barkeeper had a few extra minutes to tell the party that a dragon guarded a crystal key they would need to enter Cyanis’ Tower. The barkeeper seemed pretty busy after that and could only advise them to get more information in the Bard’s Hall.



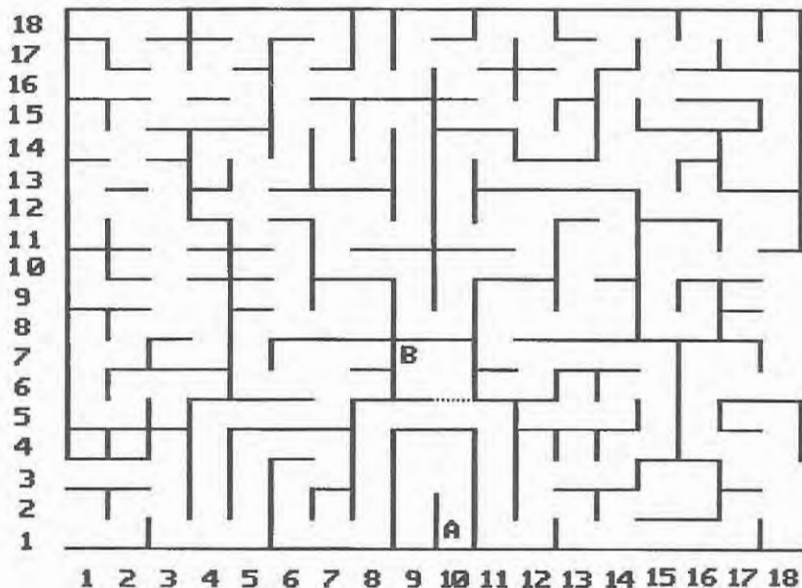

VIOLET MOUNTAIN 1

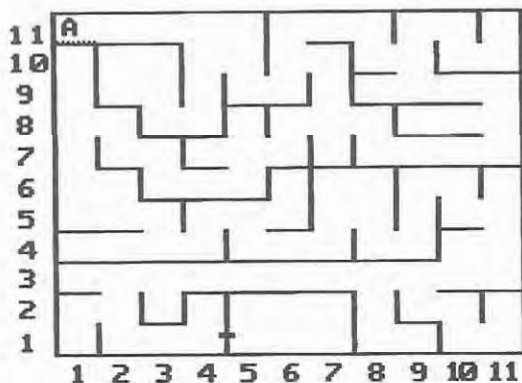

VIOLET MOUNTAIN 2

The Bard's Hall was conveniently located down the street. The party took time out to hear a couple of songs. One was a dialogue between Hawkslayer and the Rainbow Dragon. The other was a curious song about roses. Adelard wrote them down, then paid a little money to learn Kiel's Overture, a new magical song.

Hawkslayer, they learned, had sealed the dragon inside its lair under Violet Mountain. Not only Arbo, but the others, too, would have been more than happy to leave the dragon where it was. No one was really wild about the idea of waking the creature, much less trying to kill it! It seemed, however, that they had little choice, since they needed to get into Cyanis' Tower.

The magic users stopped by the Wizard's Guild to see what they could pick up. The spell of the day was Divine Intervention, a powerful spell that Thalia was happy to plunk down his gold pieces for.

After spending a restless night under the oaks of Celaria Bree, the party headed off to slay the dragon.

## LUCENCIA, VIOLET MOUNTAIN

The dragon's lair, in the northwest of Lucencia, turned out to be an immense maze. For two days the adventurers wandered through the labyrinth, mapping the twisted corridors, and for two days they breathed the foul stench of dragon. The stairs to the next level were, ironically enough, not far from where the teleport had landed them. However, the deceptive path made them hard to locate.

The party ascended and found themselves in yet another maze, though this turned out to be much smaller. The dragon's reptilian odor was so powerful that on more than one occasion Arbo thought he was going to faint. From behind the only door under the whole mountain came a rumbling noise as powerful as an earthquake. Listening to the dragon's breathing, the party stood mesmerized. Arbo finally couldn't take it anymore.

"Are we waiting for anything?!" he stammered.

Nobody could think of any reason (though they tried), so with a look of "Here goes!", the party entered. The dragon, famished from its long sleep, licked its chops, hot spittle drooling from the corners of its mouth. The party took the initiative and inflicted heavy damage on the reptile, but not enough — it still breathed, singeing their hair and clothes. After a couple more powerful volleys of spells, the beast lay dead.

Among heaps of gold and spattered blood, the party discovered the Crystal Key. Adelard couldn't resist taking some of the creature's blood. He filled a wineskin full of the thick liquid.

The party hurried out of the mountain, eager to greet the sunshine once again.

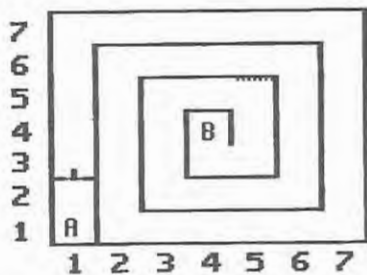

CYANIS' TOWER 1

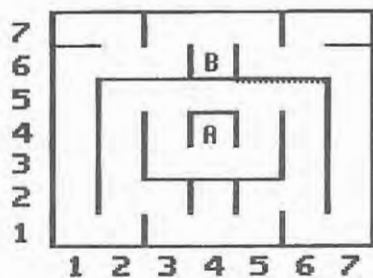

CYANIS' TOWER 2

CYANIS' TOWER 3

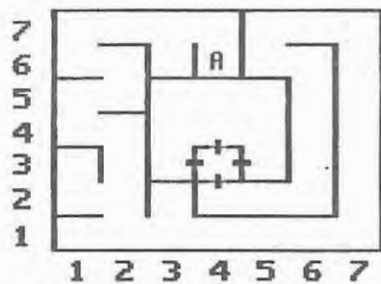

## LUCENCIA, CYANIS' TOWER

From the Violet Mountains, the party went searching for Cyanis' Tower. Along the way, they discovered rose bushes yielding the most perfect and exquisite roses they had ever laid eyes upon.

Adelard had been humming the new songs he'd heard in the Bard's Hall. He remembered that one had specifically to do with roses.

"That song is about Alliria and Cyanis," said Adelard, "And I'm sure these are the flowers mentioned in the song. We've come across the exact same colors, with the exception of the rainbow rose."

"I saw another bush just outside the city as we were leaving," said Nadya. "But it was barren. We should go see if it has bloomed yet."

Just then, Origen spied an elegant turquoise tower off in the distance. "An excellent idea, Nadya," said Origen, "but first let us investigate that tower and see if we shall need any roses at all."

The Crystal Key opened the only door into the tower, and the party walked down a spiraling corridor, at the end of which they found stairs. They hurried through the second level, past murals depicting Cyanis and Alliria. The murals in the third level were more noteworthy — some of them moved. All of them told aspects of the same story: Cyanis had been deeply in love with Alliria. When she met her early death at the hands of Tarjan, Cyanis went mad, locking himself in his tower. Cyanis' affliction was so complete, it even led him to deface the memorials he had built to his and Alliria's perfect love.

When the party came across Cyanis in a small room, he was only a shadow of the man he used to be. Cyanis sat crouched on the floor, sobbing uncontrollably. He didn't acknowledge the presence of the party, if he noticed them at all.

"The poor man suffers so," said Morolinith.

Thalia tried to comfort him, but Cyanis was in no way soothed. As she held him in her arms, an idea struck her. She cast a healing spell. Immediately Cyanis' eyes began to dry.

"Thank you," said Cyanis in a soft, humble tone. "You don't know the pain you have relieved me of. Here. Take this. You'll need it."

Cyanis handed Thalia a triangle that radiated magic. He slowly rose, then turned to start repairing the damage done to the tower. Without a word, the party left Cyanis to his work.

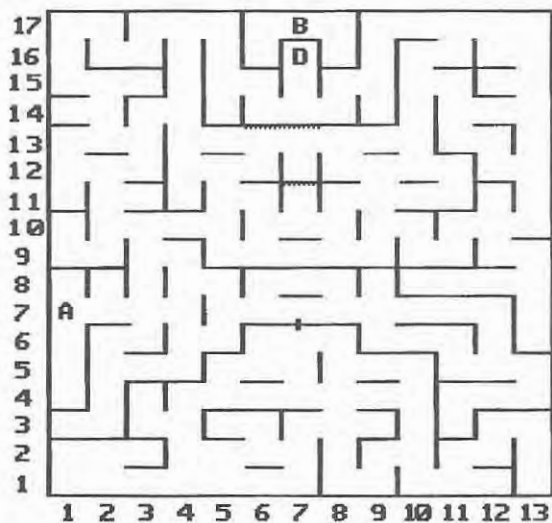

ALLIRIA'S TOMB 1

*WBR 4*

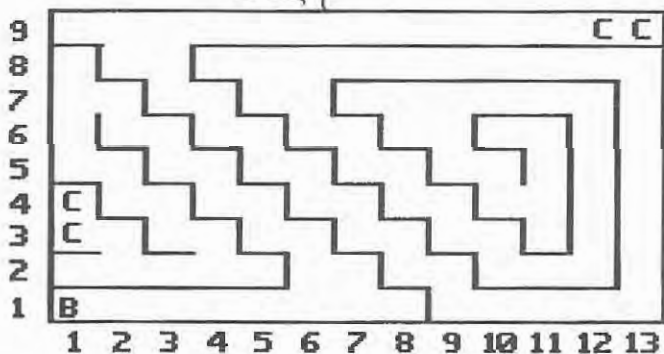

ALLIRIA'S TOMB 2

## LUCENCIA, ALLIRIA'S TOMB

After a night's rest in the Bard's Hall, Adelard woke up with an idea. The song of the roses had been running through his head all night.

"Let's gather some of the roses," he said to the others. "Believe it or not, I think the roses can help us in our search for Alliria's Tomb."

They picked four colors of roses and felt like they knew every secret Lucencia had. Then they came upon the barren rose bush outside of Celaria Bree. It hadn't bloomed since they last walked by it. Adelard thought that maybe it needed a little Water of Life. The plant grew a little, but no blooms appeared.

Adelard had another idea. "Rainbow blood for rainbow rose," he suggested. He uncorked the wineskin full of dragon's blood and poured it on the bush. It immediately put forth one beautiful rose of many colors. Adelard plucked it and presented it most graciously to Nadya.

"Get up off your knee and let's get going, you schmuck," said Nadya, unamused.

They entered the tomb area, just west of the city. While wandering around in a maze with numerous dead ends, they came upon a large black crystal. Thalia used the magic triangle and everyone ducked as the crystal exploded with a flash. Suddenly, there were stairs just to the north.

The second level had suffered no infiltration by the powers of darkness. As the party made their way along the winding path, shadowy figures of beautiful women appeared asking for the flowers the party had gathered. Each of the apparitions wanted the rose associated with a specific virtue. Adelard remembered the lyrics to the rose song and thus knew which color to give for which virtue. At one point the corridor came to an abrupt end, and a teleport device transported the party to the other half of the level. They followed the long hall to Alliria's coffin, and there they found the treasured Belt of Alliria and the Crown of Truth. With the items in hand, the party made their way out of the tomb and back to Skara Brae.

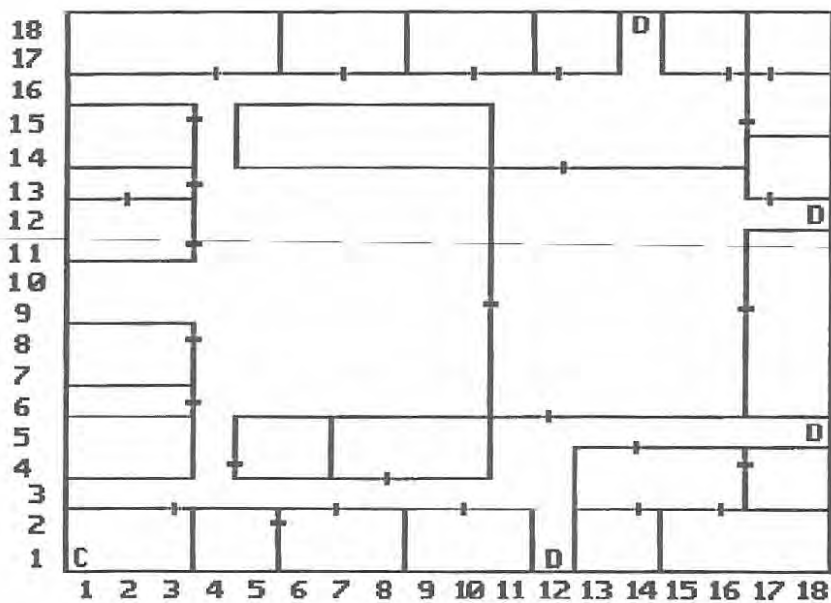

FEROFISTS

## KINESTIA, FEROFISTS

The Old Man was quick to praise the party for their success in Lucencia, and just as quick to tell them they must try to win the Hammer of Wrath and Ferofist's Helm from a renegade dwarven creation — a mechanical man named Urmech. Ferofist, the dwarven god of Kinestia, created Urmech to serve his race. However, Urmech — an intelligent being — rebelled. Urmech created many more mechanical creatures to protect him. Now the dwarves of Kinestia were locked in bitter war with Urmech and his guardians.

Morolinith shut his eyes and teleported the party from the Old Dwarven Mines to the dimension of Kinestia. They found themselves in a dark castle of dwarven construction. The walls were scarred from recent battle, the floor littered with debris. Almost immediately they ran into Hawkslayer. He seemed younger than before. Indeed, he was! Hawkslayer didn't recognize them but he greeted them as allies, once again offering his aid.

"Is this the same Hawkslayer?" Arbo asked Morolinith in a whisper as they walked eastward.

"It would appear so," said the Chronomancer, "We traverse both time and space. Perhaps we have entered the past. That would also explain why Hawkslayer recognized us in Arboria."

As they walked, Arbo tried to imagine how they could step into the past and remain themselves, or how two separate time lines — theirs and Hawkslayer's — could intersect at more than one point, or... Luckily, Arbo's meditation on the paradox of time travel was interrupted. Bizarre creatures of metal attacked the party at every turn, fighting with inhuman tenacity.

In a complex of barracks through a south passageway, the party found a key with a grip shaped only for the right hand. A similar key, only with a grip for the left hand, was discovered in what they took to be Ferofist's private quarters off through an eastern passageway. The private quarters also yielded a riddle: "Bright hand, true hand, thine are the months of six summers. Sinister hand, dark hand, three plagues upon each finger. In opposition, you ward the lair of my foolish death." The riddle, they figured out, referred to the number of times each of the keys would have to be turned in a special lock that would open the way to Urmech.



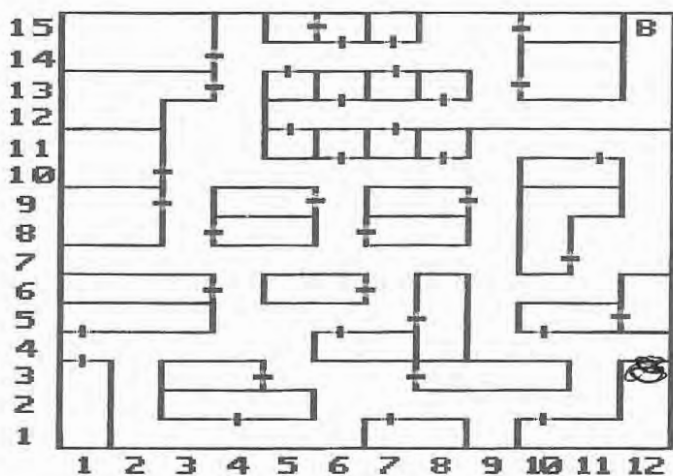

BARRACKS

PRIVATE QUARTERS

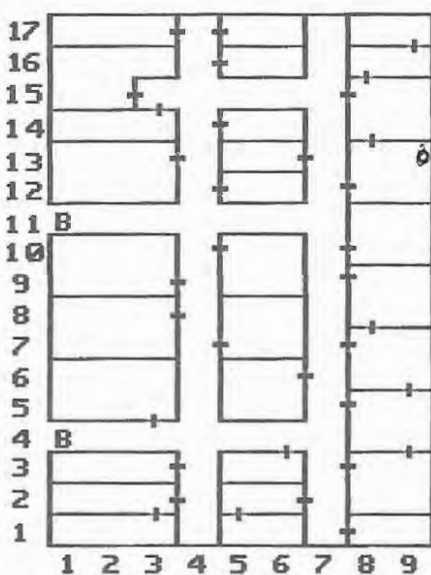

Along the northern wall of Ferofist's quarters, the party discovered another passageway that led to Urmech's workshop. A trap-door with two special locks barred the way. Arbo inserted the right key and turned it 18 times and then the left key turning it 15 times. The party successfully breached Urmech's realm. They explored two more levels, one of which was completely filled with oil. Gill, the spell that the fisherman taught them in Arboria, once again came in useful.

Dripping oil, the party hacked their way through the last level. Arbo was now fighting not only courageously, but with real fervor. He gleefully anticipated meeting Urmech in combat. The party crashed into Urmech's personal chamber only to find him sitting passively on his throne. Urmech didn't raise a finger against the intruders. Instead, he shook his head, his face full of sorrow, and asked in a touchingly human manner if violence couldn't somehow be avoided.

"Do we trust him?" asked Arbo, still clutching his sword tightly. He looked to the others, who silently nodded "yes". Urmech explained that though he had brought doom upon his creator, Ferofist, his desire to live was no crime. The robot's sincerity cooled Arbo's battle-lust. Urmech told the party they were free to take Ferofist's weapons.

Pleased by the enlightened resolution, Urmech added, "I have discovered a type of magic I will share with you, if you are willing." Arbo felt that Urmech was addressing him. Though he'd proven an adequate warrior, Arbo had known he was destined to use his intelligence as well. The magic that powerfully pervaded Urmech's realm was of a different fabric than that which either Morolinith or Thalia delved in. There was an earthy, material quality to Urmech's magic that appealed to Arbo. Using a strange machine, Urmech instilled the knowledge in Arbo and made him a Geomancer. With the Hammer and Helm, the party bade Hawkslayer farewell and returned to the Old Man.

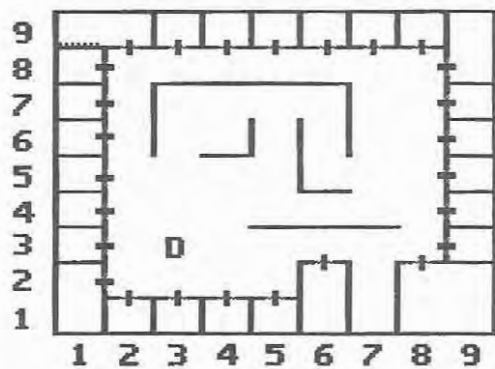

WORKSHOP 1 (URMECH)

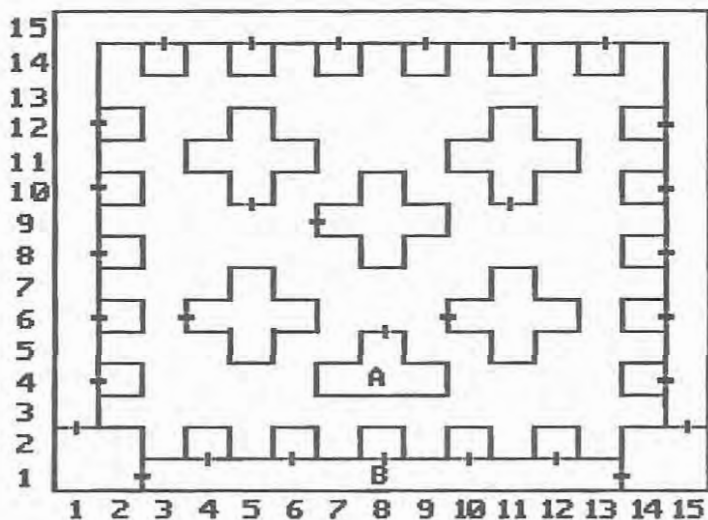

URMECH 2

# Shadow Rock

## TENEBROSIA, BLACK SCAR

It seemed to Arbo that the dimension they visited got progressively more malevolent: first the dimension of trees, then ice, light, metal...and now darkness.

Treachery thrives in this world of illusions, thought Arbo. Black Scar, the town toward which they walked, was inhospitable-sounding to say the least. Of course, its name was rightly earned — no sun rose to light the plane of darkness. The Old Man had sent them here to find a god named Sceadu and persuade him to give up his cloak and the Helm of Justice. At this moment, Arbo just wanted to get out of the creepy shadows and into a tavern, however dimly lit. Amidst the hovels of Black Scar the party found an inn.

"This sorta looks like the neighborhood I grew up in," Nadya told Arbo. "Let me do the talking."

The others watched as their thief stepped up to the bar. She exchanged a few words with the barkeeper, then a little money, too. She returned to the others frowning.

"That snake," she complained. "He slips a lot of hints but no details. Anyways, I got from him that Sceadu can be found 'in the middle of nowhere' — whatever that means — and that we gotta find a lock hidden in the Shadow Canyon, first."

"We saw a canyon not far to the south from here," said Thalia.

Before heading off to search for the lock, Adelard stopped by the Bard's Hall to see if he could learn anymore songs. He was in luck. One of the bards in residence was willing to teach him Minstrel Shield.

Morolinith, too, was ready to learn something new so he headed over to the Wizard's Guild. There he picked up Gotterdamurung, a crushing spell that added to his offensive repertoire. His accumulated experience also was enough to advance him a level.

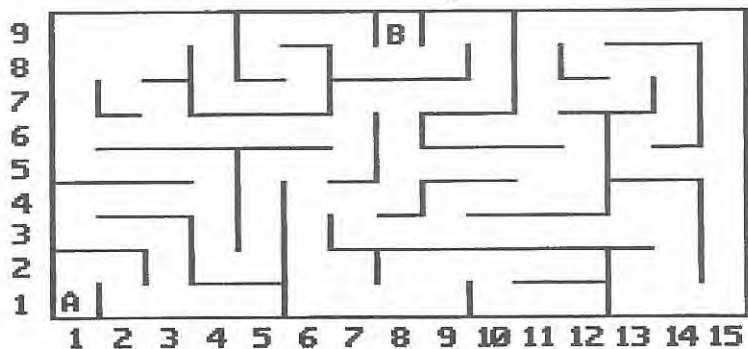

URMECH 3

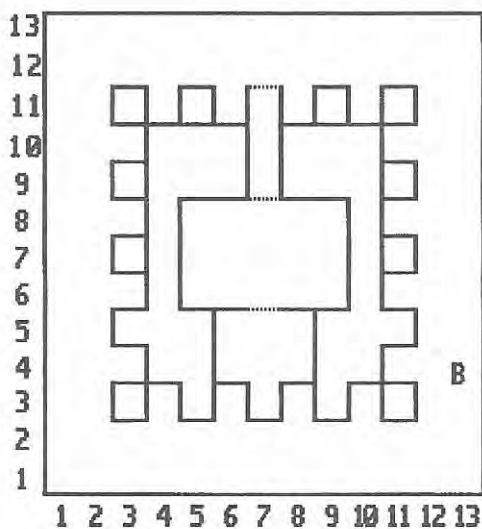

URMECH 4

## TENEBROSIA, SHADOW CANYON

They arrived at the canyon and descended, heading south through treacherous byways. The shadows cloaked bands of zombie lords that waited to prey upon adventurers. The party wandered for what seemed an eternity. Finally, someone realized that they had passed the entrance twice, though they had never changed course. They were walking in circles.

“We must conduct a more thorough search,” said Origen.

Along one passage they found a puzzling inscription: “A castle is only as weak as its strongest wall.”

“But that makes no sense,” groaned Morolinith.

“Maybe not,” said Arbo, “but haven’t you noticed that there’s one section of the canyon wall we can’t get into?” He walked due east and pointed. “Why don’t you phase that wall? It looks like the strongest wall.”

Sure enough, Morolinith’s Phase Door spell made a door that the party quickly slipped through. They almost missed the Shadow Lock, tucked away as it was in a crevice. With the odd object in hand, the party returned to the stairs.

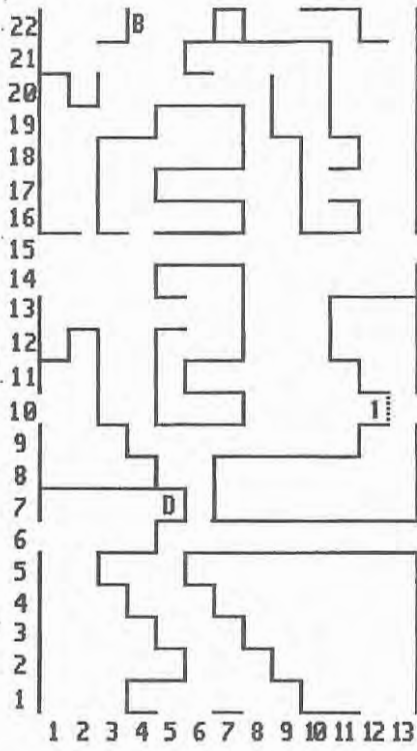

SHADOW CANYON

I = strong wall

TAR QUARRY

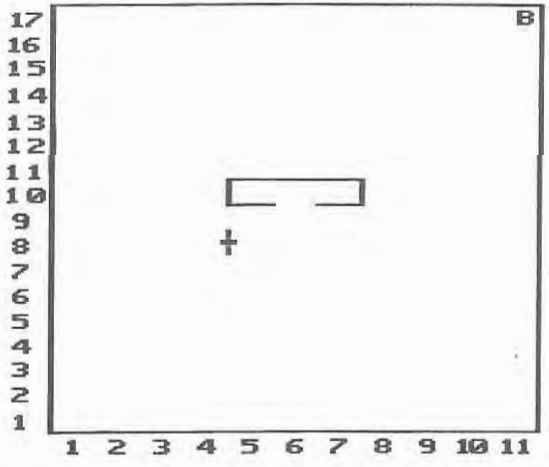

## TENEBROSIA, TARPIT

The party thought they were prepared to meet Scedu until another barkeeper in Black Scar mischievously mentioned that a lock is no good without a door.

"I've had it with these barkeepers!" growled Nadya as she prepared to split this one open.

A little intimidated, the barkeeper quickly added that the door they needed could be found in the Dark Copse.

The party walked southwest to the Dark Copse and entered. In the middle they found a ring of trees, with something barely visible in the center.

"We'll never hack our way through this," cried Adelard. The trees were too thick and the brush clung to their clothing.

"What do you suggest?" asked Origen.

"I say we go back to Black Scar and spend the night in the Bard's Hall. We can get a fresh start in the....well, after we've rested awhile," replied his brother.

With a sigh of resignation the others agreed. They went to the Bard's Hall. The big hit being sung there was a weird little ditty called the Tarpit Tango. Arbo had a sudden, divine inspiration.

"If there's a tarpit nearby," he told the others excitedly, "We could collect some and use it to burn down the Dark Copse."

Nadya seemed skeptical, but Origen thought the idea was worth a try. After the party was well-rested, they went out and found the tarpit alluded to in the song. They climbed into the pit. Morolinith spied a hut in the middle of the sticky, bubbling substance. Though the stench made it difficult to breathe, the party followed the narrow path hinted at in the song.

Nadya thought she saw something swimming in the thick tar. She narrowed her eyes and stared hard at Arbo. "This had better work, Arbo," she said, fighting to keep her balance.

"I'll take full responsibility if you fall in," said Arbo cheerfully.

"Lotta good that'll do me," replied the thief.

In the hut they found a pool of bubbling tar, thin enough to collect. Adelard filled one of his empty wineskins with the goo and the party retraced their steps back out to the Dark Copse.

Arbo smiled smugly as the ring of trees burned steadily. The thing in the middle of the trees turned out to be a door. As Origen and Adelard heaved the door to their shoulders, Arbo wandered out ahead.

"Where are you off to now in such a hurry?" asked Nadya.

"Nowhere, in particular," answered Arbo with a smirk.



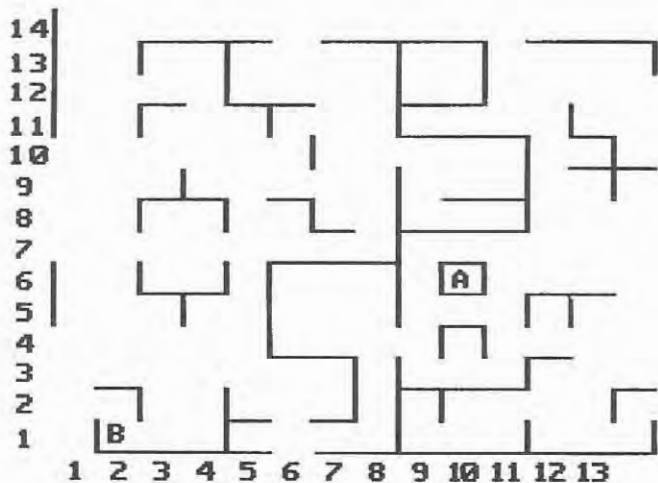

SCEADU 1

1 = phase door location

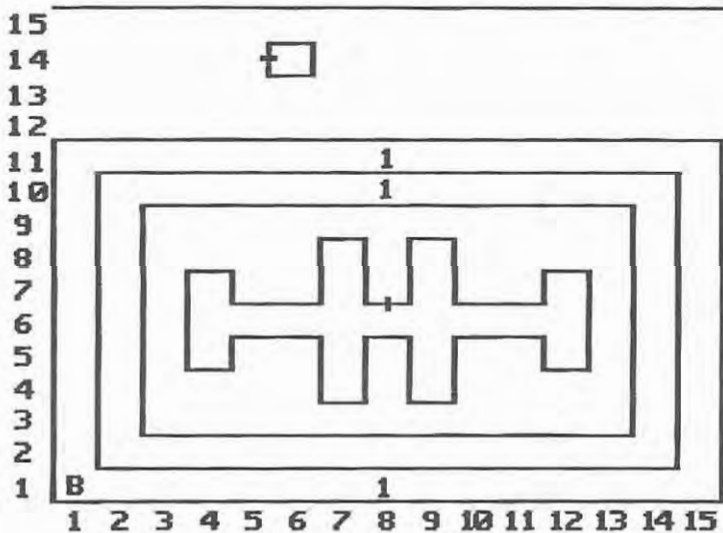

SCEADU 2

## TENEBROSIA, SCEADU

No one was really sure how to go about finding the Middle of Nowhere. The party resorted to simply wandering around the wilderness. At one point everyone stopped in their tracks. The spot they stood on was completely unremarkable except that everyone felt slightly disoriented: they were in the Middle of Nowhere.

They fitted the lock to the door, which had no effect.

"I feel stupid standing out in the wilderness holding up a door," admitted Arbo drily.

"Wait!" said Nadya. She laid the door on the ground, pulled out her delicate thieving instruments, and set to picking the lock. A mechanism in the lock clicked. Crossing her fingers, Nadya closed her eyes and gave the door a tug. It swung open to reveal stairs leading to the shadowy heart of Tenebrosia. The party descended.

Sceadu's murky realm defied logic: shadows clung to oddly defined rooms with almost a living presence. The party grew uneasy as they walked amidst deceptive walls and hushed, almost imperceptible whispers. Toward the east, behind the one way walls, they found a portal to another level below.

In the second level, the corridors formed concentric rings that seemingly closed. Using Apport Arcane and Phase Door spells, the party made their way through the rings to what appeared to be the inner sanctum of Sceadu. The party was greeted, however, not with Sceadu himself but with derisive laughter and a senseless message carved in the floor: "If Nowhere is a circle, then the middle is at the end, isn't it?"

"I knew this seemed too easy," said Origen, vexed. "We're victims of one more of Sceadu's deceptions."

"Wait," said Arbo. "If the middle isn't in the middle, where is it? It's outside."

Thalia looked at Arbo. I don't know where you get your ideas, but it sounds, well, illogical enough to me."

Following their tracks, they searched again for anything odd. On the northern wall of the outer ring, Thalia stopped. "I'm going to phase a door," she said.

After several unsuccessful attempts, she found a section of the wall that gave in. On the other side was a small chamber. Sceadu was surprised by their appearance. The god knew why they had arrived, but politely rejected their wish to take his Cloak or Helm.

Origen and Adelard leapt at Sceadu while Arbo and the mages let loose bright fireballs. Nadya disappeared into the shadows. Arbo was ready to cast another Trebuchet spell when Sceadu screamed, cursing Tarjan and falling forward. Nadya stood behind the dead god, holding his Cloak. She had yanked it from his back.

"Gosh, I didn't know it'd kill him," she said.

"I suspect Tarjan had a part to play in this," said Origen. "Let's leave this accursed place as quickly as possible."

Nadya grabbed the Helm, and soon they were standing again before Shadow Rock.

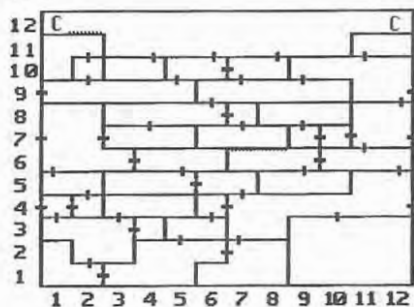

TARMITA

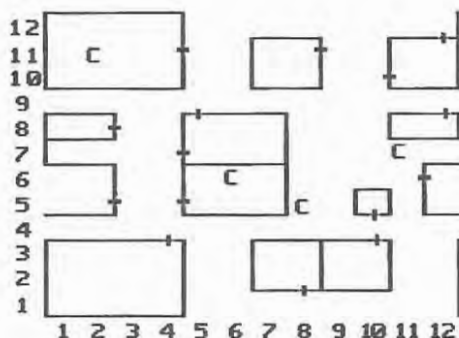

BERLIN

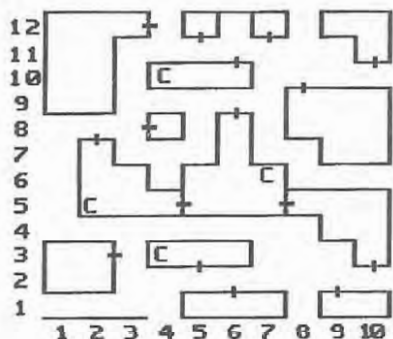

TROY

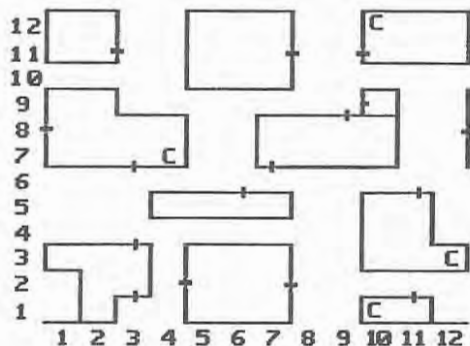

STALINGRAD

## TARMITIA, THE PLANES OF WAR

The last items the Old Man requested were Werra's Shield and the Strifespear, both of which belonged to the God of War that ruled the grim plane of Tarmitia. Werra's dimension was a timeless battleground where armies eternally clashed. From the Vale of the Lost Warriors the party appeared in a ruined building.

They started for the door, just as a group of soldiers dashed in seeking cover. They were carrying small, strange — certainly magical — weapons. Their leader, dressed in black, was yelling orders. His voice died, however, as he noticed the party standing behind him.

They look as if they're seeing ghosts, thought Arbo; which, he mused, they are.

The officer looked to his men to see if they were sharing in his hallucination. They were. He tapped his toe nervously, then decided to deal with the situation in the surest way in which he'd been trained: he ordered his men to open fire.

Before the soldiers readied their weapons, however, they were pummeled to death with magic spells.

The party wandered out into the war-torn streets of this place called Berlin.

"Strange magic they have here," said Morolinith as he crushed a group of green-uniformed soldiers under a Fatal Fist.

"Yes," yelled Thalia in return, "It's rather like Urmech's devices."

The party wandered east. At one point a spirit passed overhead and whispered, "I am Ares." A little farther on, a phantom death's-head appeared, asking, "Who am I?"

"Ares?" guessed Arbo, but the death's-head disappeared.

In a building to the northwest, the party stepped through a hole in time and found themselves in a place that was a little more familiar. Bronze-clad legionnaires fought in vain against hordes of barbarians dressed in thick furs. In the middle of the city another death's-head appeared asking, "Who am I?"

"Ares?" Arbo tried again, biting his lip. The death's-head disappeared. Arbo looked at the others and shrugged.

To the west of this building they found another hole in time. Since the holes seemed to be two-way, the party decided they couldn't get too lost by entering another.

Upon arrival, the party was immediately set upon by spearmen. These soldiers looked similar to those of the previous dimension, in that they also wore bronze armor. However, the style and make of their uniforms were different. The soldiers took them to be enemies, and with a passionate cry of "Troy!", attacked. The party dealt with the Trojan soldiers coolly, destroying their foes in the first volley of spells.

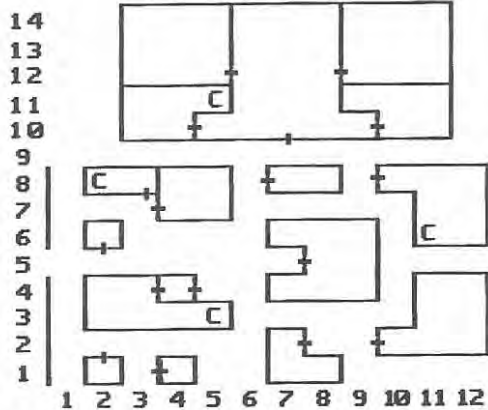

K'UN WANG

NOTTINGHAM

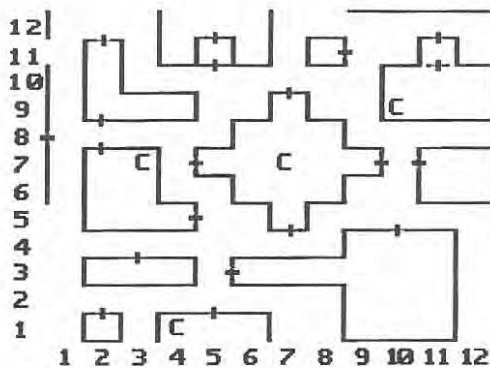
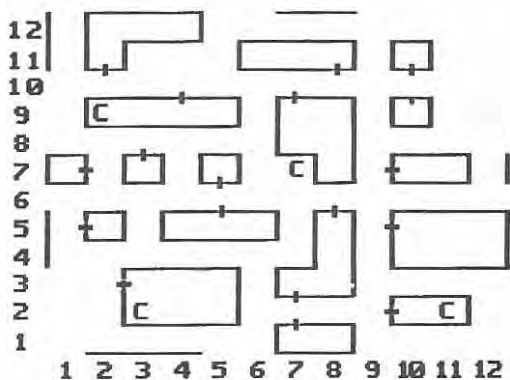

ROME

Several more groups of soldiers attacked while the party investigated the building they appeared in. In a corner to the west, yet another death's-head appeared, asking once again the familiar question.

Arbo sighed, not expecting much, and said "Ares?"

The party transported to another place. They found themselves in a ten foot cubicle with one door leading north. A chilling wind passed, whispering "I am Yen-Lo-Wang."

Morolinitz quickly wrote down the new name. The party stepped out into the middle of the clash between opposed groups of Norman knights and Saxon peasants. In the mayhem, though, no one noticed the party slink past.

In the center of the town they encountered another death's-head. Yen-Lo-Wang was not the name of the War God here. The party continued to the northwest, where they entered a long hall through which they passed into another time and another place. The combatants were similar to those the party first encountered in Tarmitia, but the city they were destroying was different. It was also deathly cold in this place called Stalingrad.

In a building to the west they stepped through a time portal and the climate was immediately better. There was a war going on here as well. Barbarians — Mongols, the party inferred by the cries in the streets — were sacking the city of K'un Wang.

Origen halted the party. "Do any of you have an idea how we're going to find Werra?" he wanted to know.

"I think we have to correctly name all of the death's-heads," said Morolinitz.

"But that means we'll have to revisit each of these places several times!" groaned Adelard.

"If we have to, that's what we'll do," said Origen. "Anything else?"

"That's just one option," said Arbo. "An alternative is to go straight to Berlin. We can just give the name 'Tyr' and then 'Werra'. Cuts down on the travel." Nobody knew where Arbo figured this out, least of all Arbo. Origen pondered this bit of advice, but decided to carry out their original plan to visit all the dimensions.

The party passed through each of the seven battlefields between two to four times. Whenever they received a name for a War God, they had to travel to the plane on which that god ruled, speak his name to the death's-head, and get teleported to another plane where they would receive a new name.

The party eventually got teleported to Berlin, where they had started. They returned to the death's-head they had first encountered and spoke its name, "Tyr." The death's-head here had another bidding as well: "Now say my true name, if you dare."

Arbo said "Werra," and they were teleported to Werra's Hall of Tarmitia.

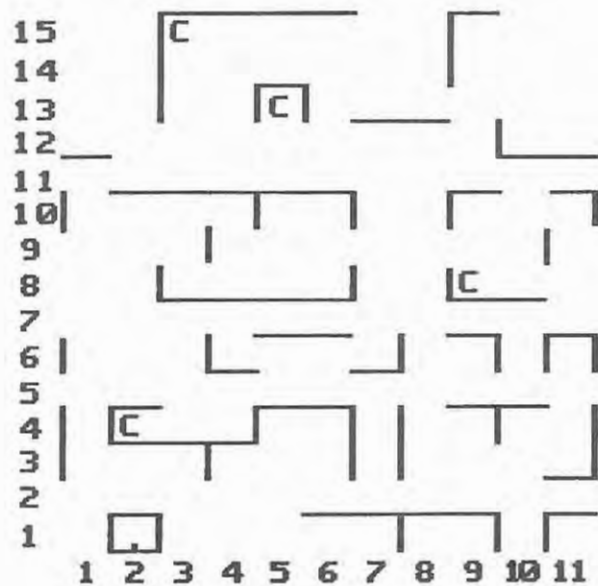

WASTELAND

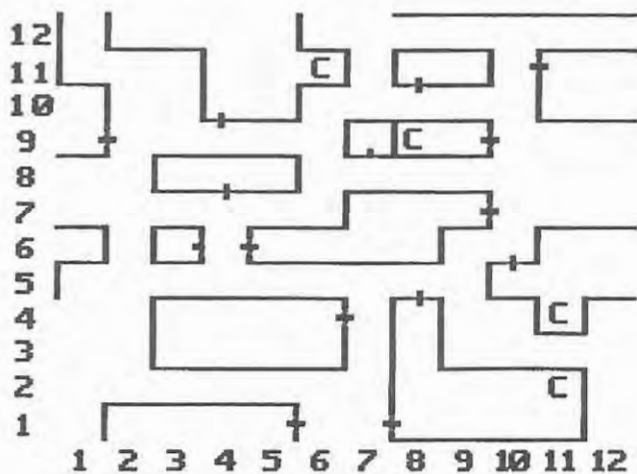

HIROSHIMA

## TARMITIA, WERRA

Warriors from all times patrolled the corridors of the god's home. The party killed Greeks fighting side-by-side with samurais, Normans, bikers, and stormtroopers.

In the northeast corner was a hole in time through which they could see the Vale of Lost Warriors in Skara Brae. The party fought their way to Werra in the southwest corner.

Werra enjoyed the combat the party afforded him. He laughed heartily, even as the last blow of Origen's sword sent him reeling. Werra lay still, his blood draining onto the floor.

Arbo rested on his sword. "That was hard work," he panted.

Werra sat up in a pool of his own blood. The party stood stunned as Werra laughed some more, blood streaming down his face.

"That's the best fight since I battled Hawkslayer and gave him Strifespear," said the god.

Werra laughed some more. Arbo had problems seeing what was so funny. The god told the dumbfounded mortals they had earned his shield. Werra ceased, however, as six black shapes materialized around him.

"Black slayers!" cried Adelard. Arbo trembled as he cast a spell that sent a rain of fire down on a black slayer. The evil creature turned and pointed at him. Arbo felt an intense chill run through his body as if a long sliver of ice penetrated his heart. He grasped at his belt for his sword, but his numb fingers could feel nothing. The black slayer faded into darkness as Arbo fell to the floor, unconscious.

Arbo awoke to find a kindly priest bent over him.

"You were wise not to travel too far into the realm of the dead," said the priest. "Or perhaps you had good reason to return to this life?" The priest departed through some curtains. Arbo realized he was in the small shrine just west of Skara Brae. Adelard and Nadya were seated close by.

"What happened?" asked Arbo.

"A black slayer slew you," said Adelard.

"And Werra?"

"Tarjan killed him and stole his soul. There was nothing we could do for him," said Nadya.

"We must go see the Old Man at once!" cried Arbo, jumping up from the bed.

"It's too late!" cried Nadya, "He's suffered the same fate as Werra."

"He's dead?" asked Arbo in disbelief.

"Yes," said Adelard, "He told us we must go help Hawkslayer, who is already in Malefia, the Land of Evil. He warned us to destroy Tarjan before he destroyed all reality. He hid the items we collected in the storage building east of the city gates."



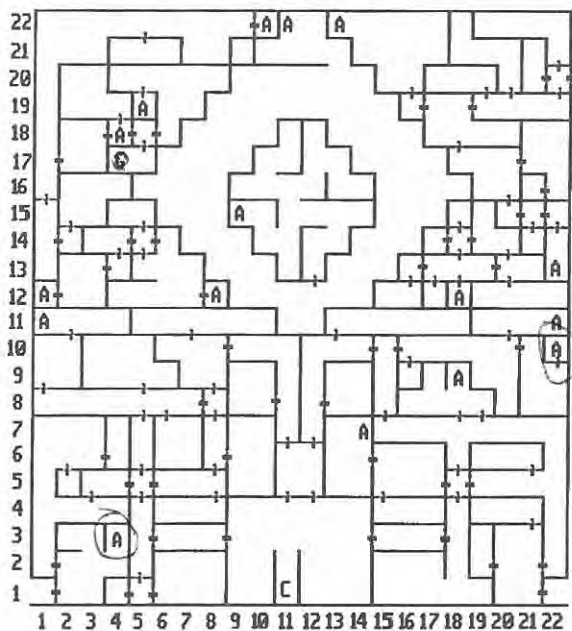

MALEFIA 2

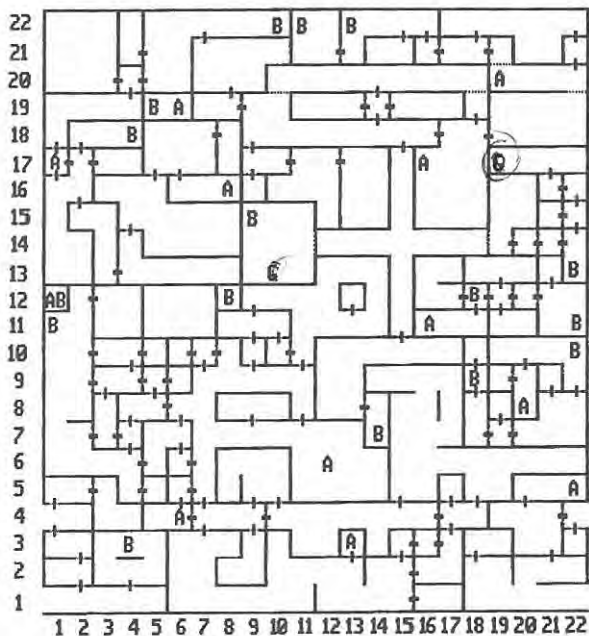

Arbo considered for a moment the prospects of entering the very heart of evil.

As if reading his mind, Nadya quietly said, "You know, Arbo, you're not obliged to come along. You've already come close to death. We wouldn't think less of you if you returned to your lord."

Arbo had made his decision long before. "I have to see how the story ends," he said with a smile.

## MALEFIA

The Mud Laden Water was not even a foretaste of the evil dimension.

"Do we have everything?" asked Morolinith one more time. Everyone nodded. "Good," said the Chronomancer, and with a word they were standing at the gates of Malefia.

"Oh no!" were Arbo's first words in their new dimension. Not more than twenty paces before them lay Hawkslayer, dead, his body flattened by some immense power. His hand still clutched the Strifespear. The party was utterly stunned. Arbo picked up the artifact. In silence, the party walked around the body. They walked slowly, their steps weighed by the sudden loss of their friend and by the burden that was squarely on their shoulders. They realized they alone carried the artifact capable of freeing the gods imprisoned by Tarjan.

The party wandered through a complex three-dimensional maze. For roughly a week they mapped the many dark corridors, portals, stairways and teleport traps that made up Malefia, all the while wreaking terrible vengeance upon Tarjan's fell minions. There were Rock men, who threatened to turn the party to stone; ungodly Vortexes that seemed immune to magic; and Death Wardens who would only go down after several castings of Gotterdamurung. They found the gods scattered throughout Malefia, each one encased in black ice. The artifacts they had collected here found their worth; only with the appropriate items could the gods be set free.

"That was the easy part," said Arbo after the gods were released from their bonds. "Now for the task that may do us a little harm." For some reason, his eyes sought Nadya, who was looking back just as intently.

The party had found that the central core of level three was inaccessible by normal means. It was obvious Tarjan dwelled there. With the way open by the freeing of all the gods, the party entered the central core from the south. They fought their way through Tarjan's most powerful lieutenants.

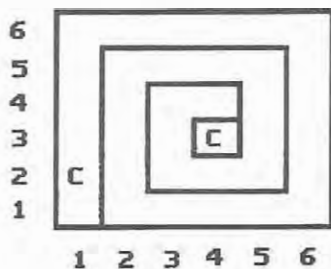
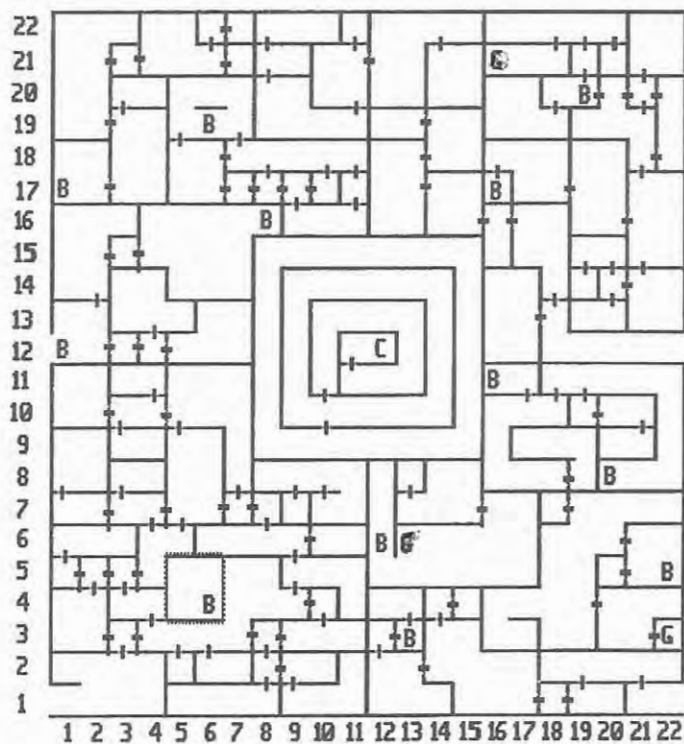

When the party finally met Tarjan, he was in reach of neither sword nor spell. The party couldn't get through the endless line of creatures that the Evil One summoned from the bowels of Hell. But to the side of the fray, Nadya slipped off into the shadows. Arbo didn't have time to wonder if she was alive or not. He cast spell after spell until the corpses formed a wall around the party. Tarjan never saw the thief as she crept up behind him. When her attack came, Tarjan's screams echoed throughout the chamber and beyond, through the vast halls of Malefia and into the surrounding void.

## SCRAPWOOD TAVERN, BACK HOME

"HERE'S TO US FOR SMUSHIN' THE BAD GUY!" screamed Arbo as he thrust a toast into the air. The foam head splashed out of the tankard and into Morolinith's face. "HA HA HA HA!" he wailed in his drunken bliss.

"So what do you do now that Skara Brae and the six dimensions have been restored?" asked the only slightly more sober Nadya. She leaned heavily on Arbo's left arm. "Will you go back to whassisface?" She was referring to Sir Rand of Nielan, Arbo's long-forgotten about lord.

"He will stay with us!" demanded Origen, who brought his tankard crashing to the table.

"He should learn how to control himself," laughed a beer-soaked Morolinith.

"He should become a bard!" cried Adelard, "And work in a yard, and learn to play cards, which isn't so hard, unless there's a guard, who eats lots of lard, and the party is marred —"

"ENOUGH!" cried Arbo, doubled over in laughter. "I AM GOING TO..." He realized that he was screaming and paused. "I am going to be my own man. No more picking bits of Hookfang from someone else's sword. No more 'yes mi'lord this and yes mi'lord that'. I'm a god after all! I'VE got a star in the heavens to prove it."

"We're gods with stars, too," Nadya quickly added.

"Lemme tell you, it's a wonderful life," continued Arbo. "Too short to be somebody's flunky squire." He looked at his friends and then stared silently into his beer. Finally, he lifted his head. "What was I talking about?"

"Working with us!" said Origen.

"Yeah yeah yeah," the rest chimed in.

"Okay. Lemme think about it." Arbo raised his glass, this time without spilling a drop. The others met him with theirs. The clinking of glass was the most popular song as the toasting ran deep into the night. ♦

## NOTICE

ELECTRONIC ARTS RESERVES THE RIGHT TO MAKE IMPROVEMENTS IN THE PRODUCT DESCRIBED IN THIS CLUEBOOK AT ANY TIME AND WITHOUT NOTICE.

THIS CLUEBOOK, AND THE SOFTWARE DESCRIBED IN THIS CLUEBOOK, ARE COPYRIGHTED. ALL RIGHTS ARE RESERVED. NO PART OF THIS CLUEBOOK OR THE DESCRIBED SOFTWARE MAY BE COPIED, REPRODUCED, TRANSLATED, OR REDUCED TO ANY ELECTRONIC MEDIUM OR MACHINE-READABLE FORM WITHOUT THE PRIOR WRITTEN CONSENT OF ELECTRONIC ARTS, 1450 FASHION ISLAND BOULEVARD, SAN MATEO, CALIFORNIA 94404-2064

ELECTRONIC ARTS MAKES NO WARRANTIES, EXPRESS OR IMPLIED, WITH RESPECT TO THIS CLUEBOOK, ITS QUALITY, MERCHANTABILITY, OR FITNESS FOR ANY PARTICULAR PURPOSE. THIS CLUEBOOK IS PROVIDED "AS IS." ELECTRONIC ARTS MAKES CERTAIN LIMITED WARRANTIES WITH REGARD TO THE SOFTWARE AND THE MEDIA FOR THE SOFTWARE.

SOFTWARE © 1988 INTERPLAY PRODUCTIONS, INC.  
ALL RIGHTS RESERVED.

CLUEBOOK BY DAVID LUOTO  
EDITED BY ZINA J. YEE

THANKS TO MICHAEL MEISCHEID,  
MARK WALLACE, AND BING GORDON FOR VERIFYING  
THE ACCURACY OF THIS CLUEBOOK.

© 1988 ELECTRONIC ARTS. ALL RIGHTS RESERVED.

ISBN 1-55543-236-0



**ELECTRONIC ARTS®**

1450 Fashion Island Blvd., San Mateo, CA 94404 (415) 571-7171